



BOOK 2020
LED LIGHTING
SOLUTION

Ω HOMEGA[®]
ILLUMINAZIONE

INDEX

INTERNO

PANNELLI

PANNELLI LED 60X60	08
PANNELLO LED 60X60 UGR<19	09
PANNELLO LED 30X120	10
PANNELLO LED 30X120 UGR<19	11
PANNELLO BACKLITE	12

INCASSI

ERCOLE	16
ERCOLE IP54	17
VULCANO EVO	18
LEDSPOT_TRP1	20
QUADRO_30	22
DIN	24
DON	25
SPLASH	27
HELIOS_50 FISSO	28
HELIOS_50 REGOLABILE	29

SOFFITTO / PARETE

PLAFOLED_T	32
PLAFOLED_Q	33
HYDRA T	34
HYDRA Q	35
PANNELLO TONDO	36
ISIDE	37
MAYA	38
DISCO	39
LUCE QUADRO	40

INDUSTRIALE

HORUS	44
ATON	45
PRO_STAGNALED_IP65	46
STAGNA_IP65	47
CARONTE	48

INTERNO

PROIETTORI

ATLANTE	52
LAMPO	54
LAMPO C/SENSORE	58

SOFFITTO / PARETE

ZAGOR	62
MOON	63
LUNA_T	64
LUNA_O	65
LADY_T	66
LADY_Q	67
SIGNUS	68
PROTEO	69
WALLY	70
WALLY OPEN	71
ELEGANT	72
RINGO	73
KANDO_T	74
KANDO_Q	75
BRICK	76

TRANSFORMERS E ACCESSORI 80

PRICE LIST 82

PANNELLI

INTERNO

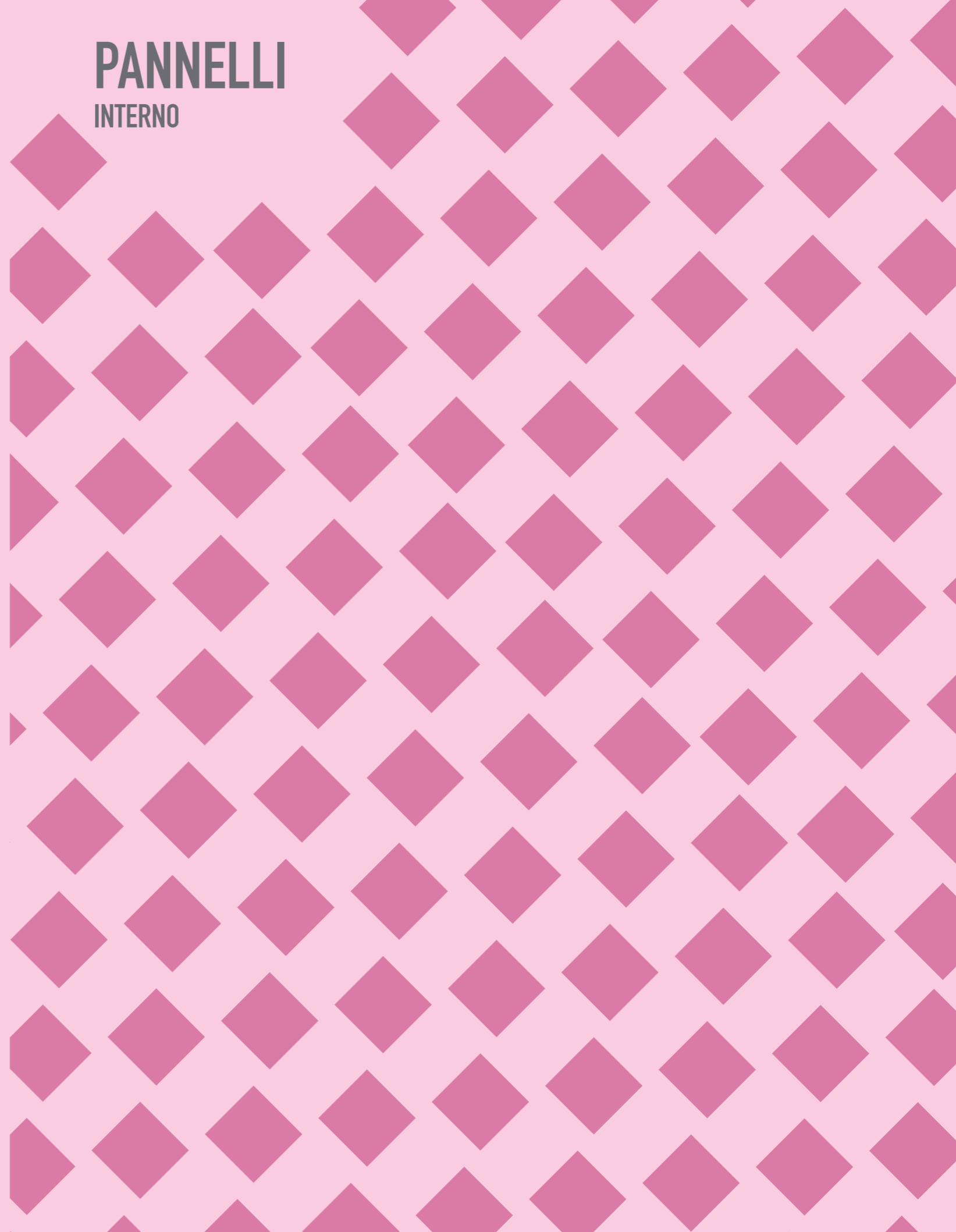

PANNELLO_LED

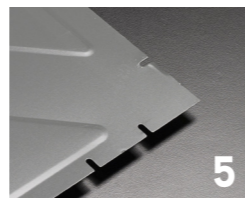
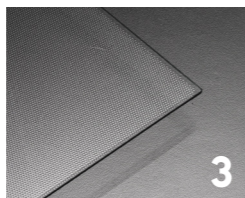
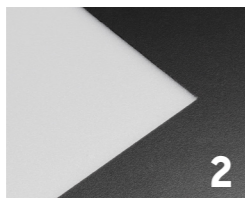
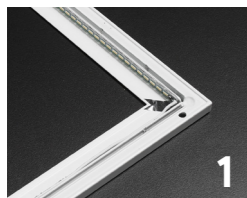
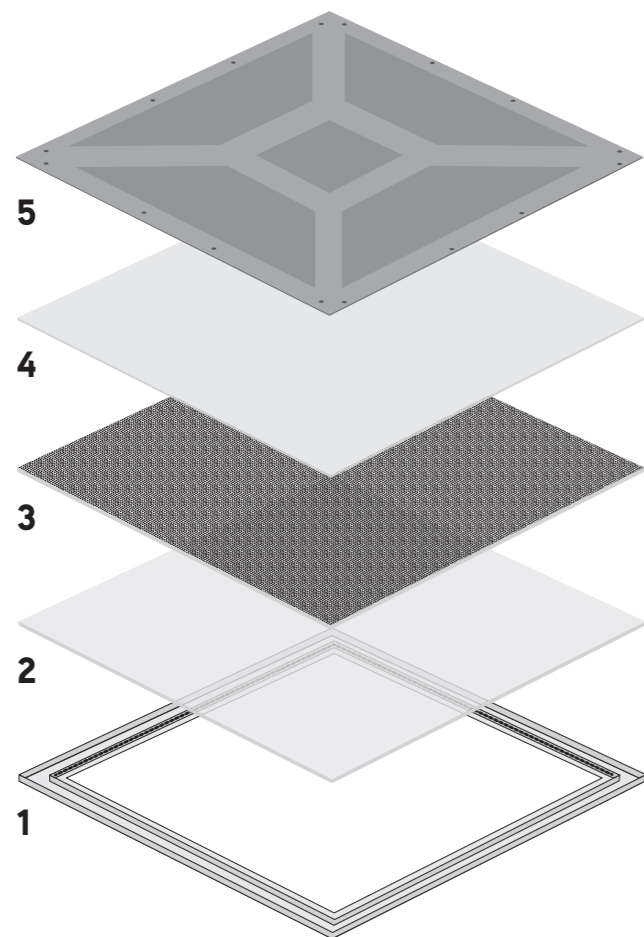

CORNICE ALLUMINIO CON STRISCE LED
 Profilo in alluminio da 290 gr concepito per una migliore dissipazione del calore e dotato di una struttura meccanicamente più stabile. Cornice di alluminio con striscia LED con chip 4014 ad alta efficienza anziché chip 2835 a bassa efficienza luminosa.

ALUMINIUM FRAME WITH LED STRIPS
 Aluminium frame with 290g structure provides a better heat dissipation and a more stable mechanical structure. Led strips high lumen efficiency 4014 chip instead of low efficiency 2835 chip.

DIFFUSORE
 Diffusore in PS da 1,2 mm garantisce l'uniformità dell'emissione ed il mantenimento della temperatura colore (*K). Non usiamo diffusori in PP che ingialliscono in breve tempo modificando la temperatura di colore.

DIFFUSER
 1,2 mm PS diffuser ensures light smoothness and colour temperature maintenance (*K) over time. We do not mount PP diffusers which turn yellowish and modify the colour temperature in a very short time

LGP
 In PMMA da 2,8 mm di qualità assicura un alto indice di mantenimento del flusso luminoso anziché PP o PS che causano un decadimento del flusso luminoso nel breve periodo.

LGP
 2,8 mm quality PMMA LGP ensures high luminous flux maintenance over time instead of PP or PS which cause a drastic lumen depreciation.

CARTA RIFLETTENTE
 Foglio PET a doppio rivestimento che migliora l'efficienza luminosa.

PAPER REFLECTOR
 Double coated PET sheet which improves light efficiency.

TAMPONAMENTO DI CHIUSURA

CLOSING SHEET



PANNELLO_LED 60X60



Apparecchio da incasso/
soffitto/sospensione LED integrato
Corpo in alluminio verniciato
LGP in PMMA
Diffusore in PS
Driver incluso

Recessed/ceiling/suspension fitting
with built-in LED
Painted aluminium body
PMMA LGP
PS Diffuser
Driver included

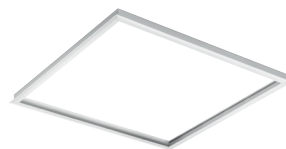
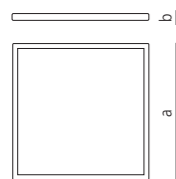
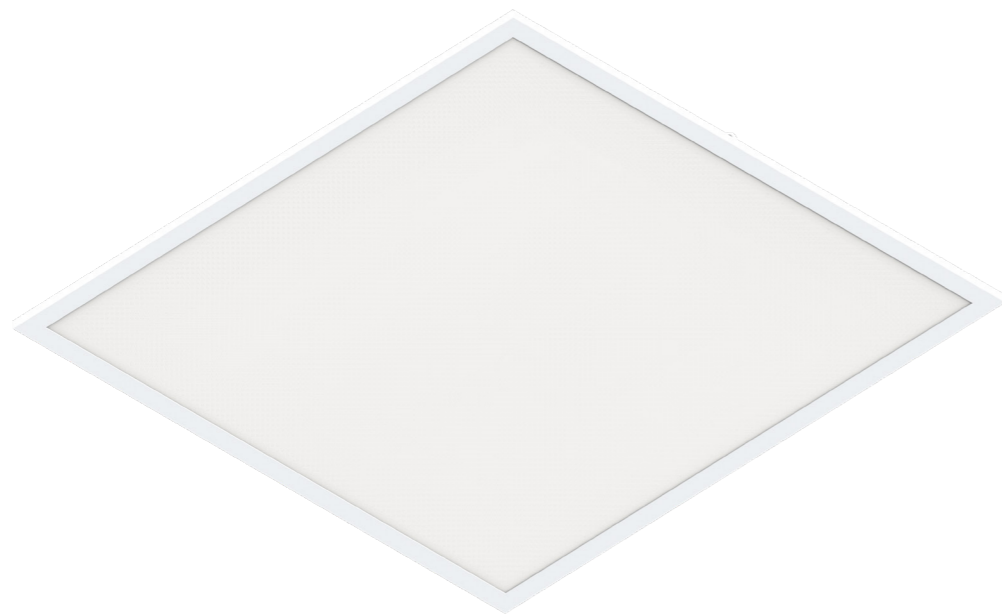

42538
cornice per montaggio cartongesso /
frame for recessed mounting
☑ 620x620

42539
accessorio soffitto H mm. 43 /
ceiling accessory H mm. 43

11622/2
accessorio sospensione H mt. 2 /
suspension accessory H mt. 2



CODICE / CODE	41649	41650
BEAM	110°	110°
COLORE / COLOUR	bianco/white	bianco/white
COLORE LUCE / COLOR T	3000K	4000K
LUMEN	3600	4000
CRI	>80	>80
LED	SMD 4014	SMD 4014
WATT	40W	40W
SUPPLY	230V 50/60Hz	230V 50/60Hz
DRIVER	950mA/27-42V flicker-free	950mA/27-42V flicker-free
KG	2,1	2,1
PCS	5	5
DIMENSIONI / DIMENSIONS		
a	595	595
b	9	9

ACCESSORI	42683	Driver ONE4ALL 220-240V 12-42V 650-1110mA Dali, Push, 1-10V	listino prezzi Logica/Logica pricelist
ACCESSORIES	40314	Driver 110-277V 14-42V 400-1100mA 1-10V	
	12551	Emergenza/Emergency 30% - 90min MAX 40W	listino prezzi Logica/Logica pricelist

PANNELLO LED 60x60 UGR<19



Apparecchio da incasso/soffitto/
sospensione LED integrato
Corpo in alluminio verniciato
LGP in PMMA
Diffusore in PS
Driver incluso

Recessed/ceiling/suspension fitting
with built-in LED
Painted aluminium body
PMMA LGP
PS Diffuser
Driver included

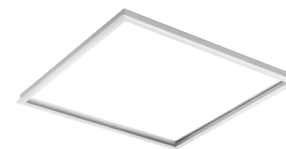
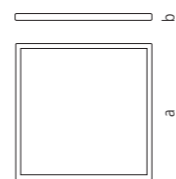

42538
cornice per montaggio cartongesso /
frame for recessed mounting
☑ 620x620

42539
accessorio soffitto H mm. 43 /
ceiling accessory H mm. 43

11622/2
accessorio sospensione H mt. 2 /
suspension accessory H mt. 2



CODICE / CODE	41653	41654
BEAM	110°	110°
COLORE / COLOUR	bianco/white	bianco/white
COLORE LUCE / COLOR T	3000K	4000K
LUMEN	3600	4000
CRI	>80	>80
LED	SMD 4014	SMD 4014
WATT	40W	40W
SUPPLY	230V 50/60Hz	230V 50/60Hz
DRIVER	950mA/27-42V flicker-free	950mA/27-42V flicker-free
KG	2,1	2,1
PCS	5	5
DIMENSIONI / DIMENSIONS		
a	595	595
b	9	9

ACCESSORI	42683	Driver ONE4ALL 220-240V 12-42V 650-1110mA Dali, Push, 1-10V	listino prezzi Logica/Logica pricelist
ACCESSORIES	40314	Driver 110-277V 14-42V 400-1100mA 1-10V	
	12551	Emergenza/Emergency 30% - 90min MAX 40W	listino prezzi Logica/Logica pricelist

PANNELLO_LED 30x120



Apparecchio da incasso/
soffitto/sospensione LED integrato
Corpo in alluminio verniciato
LGP in PMMA
Diffusore in PS
Driver incluso

Recessed/ceiling/suspension fitting
with built-in LED
Painted aluminium body
PMMA LGP
PS Diffuser
Driver included

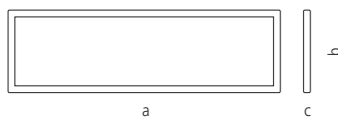

42542
cornice per montaggio cartongesso /
frame for recessed mounting
320x1220



42540
accessorio soffitto H mm 43 /
ceiling accessory H mm 43



11622/3
accessorio sospensione H mt. 2 /
suspension accessory H mt. 2



CODICE / CODE	41651	41652
COLORE / COLOUR	bianco/white	bianco/white
COLORE LUCE / COLOR T	3000K	4000K
LUMEN	3600	4000
CRI	>80	>80
LED	SMD 4014	SMD 4014
WATT	40W	40W
SUPPLY	230V 50/60Hz	230V 50/60Hz
DRIVER	950mA/27-42V flicker-free	950mA/27-42V flicker-free
KG	2,4	2,4
PCS	5	5
DIMENSIONI / DIMENSIONS		
a	1195	1195
b	295	295
c	9	9

ACCESSORI	42683	Driver ONE4ALL 220-240V 12-42V 650-1110mA Dali, Push, 1-10V	listino prezzi Logica/Logica pricelist
ACCESSORIES	40314	Driver 110-277V 14-42V 400-1100mA 1-10V	
	12551	Emergenza/Emergency 30% - 90min MAX 40W	listino prezzi Logica/Logica pricelist

PANNELLO_LED 30x120 UGR<19



Apparecchio da incasso/
soffitto/sospensione LED integrato
Corpo in alluminio verniciato
LGP in PMMA
Diffusore in PS
Driver incluso

Recessed/ceiling/suspension fitting
with built-in LED
Painted aluminium body
PMMA LGP
PS Diffuser
Driver included

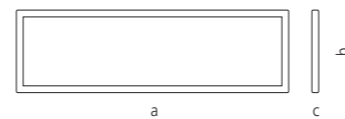

42542
cornice per montaggio cartongesso /
frame for recessed mounting
320x1220



42540
accessorio soffitto H mm 43 /
ceiling accessory H mm 43



11622/3
accessorio sospensione H mt. 2 /
suspension accessory H mt. 2



CODICE / CODE	41655	41656
COLORE / COLOUR	bianco/white	bianco/white
COLORE LUCE / COLOR T	3000K	4000K
LUMEN	3600	4000
CRI	>80	>80
LED	SMD 4014	SMD 4014
WATT	40W	40W
SUPPLY	230V 50/60Hz	230V 50/60Hz
DRIVER	950mA/27-42V flicker-free	950mA/27-42V flicker-free
KG	2,4	2,4
PCS	5	5
DIMENSIONI / DIMENSIONS		
a	1195	1195
b	295	295
c	9	9

ACCESSORI	42683	Driver ONE4ALL 220-240V 12-42V 650-1110mA Dali, Push, 1-10V	listino prezzi Logica/Logica pricelist
ACCESSORIES	40314	Driver 110-277V 14-42V 400-1100mA 1-10V	
	12551	Emergenza/Emergency 30% - 90min MAX 40W	listino prezzi Logica/Logica pricelist

PANNELLO BACKLITE



Apparecchio da incasso
Corpo in alluminio verniciato
Diffusore in PS
Driver incluso

Recessed
Painted aluminium body
PS diffuser
Driver included

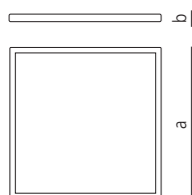
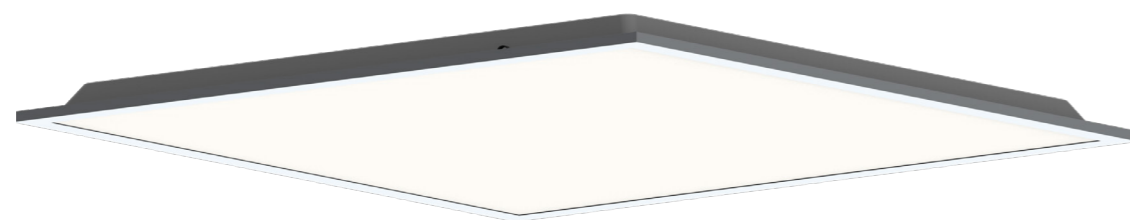

CODICE / CODE	41657
BEAM	110°
COLORE / COLOUR	bianco/white
COLORE LUCE / COLOR T	4000K
LUMEN	3200
CRI	>80
LED	SMD 4014
WATT	40W
SUPPLY	230V 50/60Hz
DRIVER	950mA/27-42V flicker-free
KG	1,5
PCS	2/6
DIMENSIONI / DIMENSIONS	
a	595
b	30

ACCESSORI	42683 Driver ONE4ALL 220-240V 12-42V 650-1110mA Dali, Push, 1-10V	listino prezzi Logica/Logica pricelist
ACCESSORIES	40314 Driver 110-277V 14-42V 400-1100mA 1-10V	
	12551 Emergenza/Emergency 30% - 90min MAX 40W	listino prezzi Logica/Logica pricelist



INCASSI
INTERNO

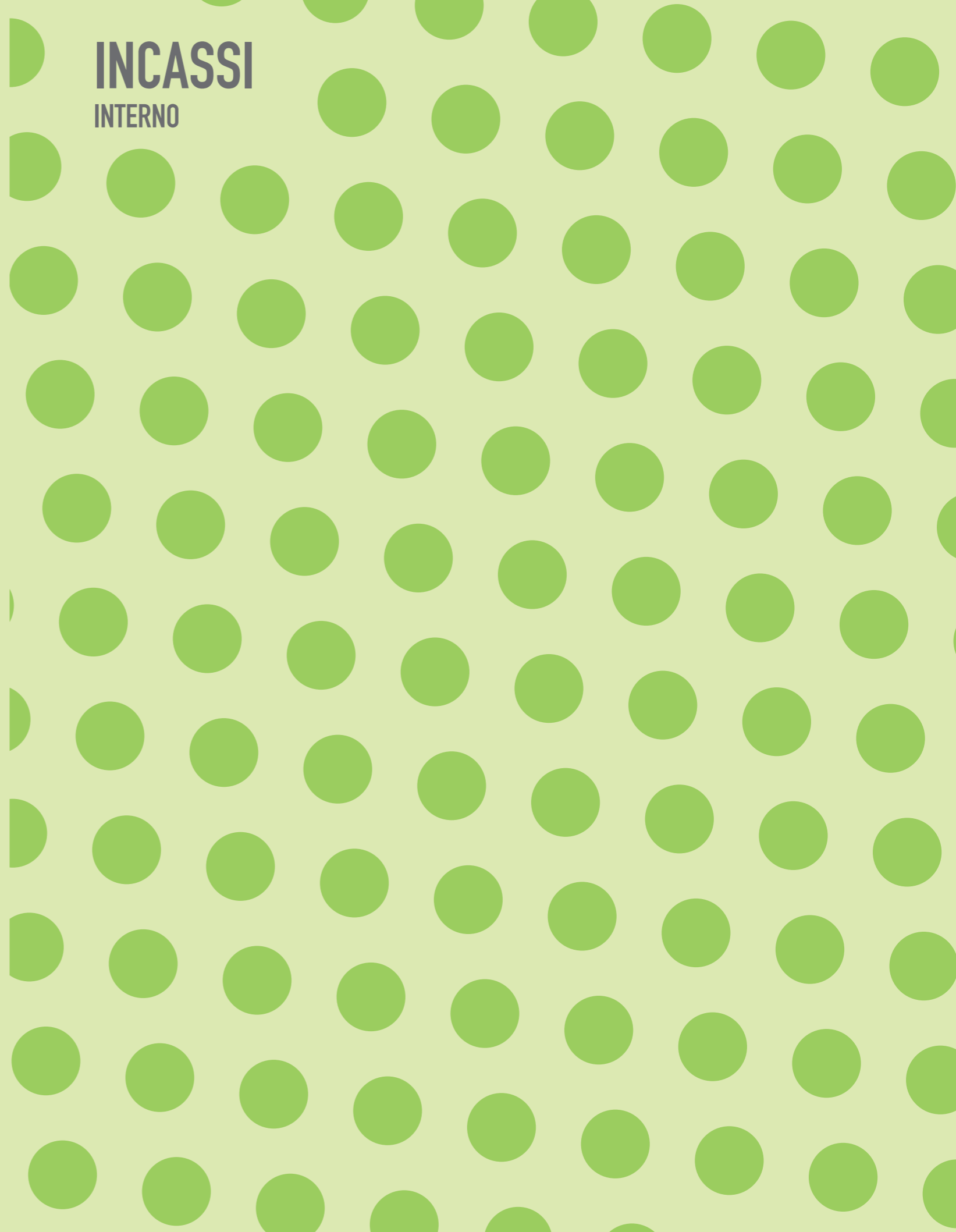

ERCOLE



Incasso LED integrato
Corpo in alluminio
Diffusore in PC opale
Driver incluso

Recessed fitting with built-in LED
Aluminium body
Opal PC diffuser
Driver included

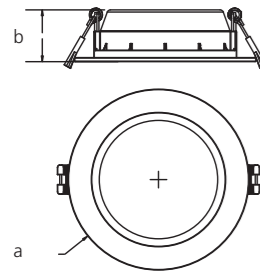

CODICE / CODE	41253	41254
BEAM	90°	90°
COLORE / COLOUR	bianco/white	bianco/white
COLORE LUCE / COLOR T	3000K	4000K
LUMEN	1980	2090
CRI	80	80
LED	EPISTAR	EPISTAR
WATT	22W	22W
SUPPLY	220-240V	220-240V
DRIVER	50.4-59.4V/350mA	50.4-59.4V/350mA
KG	0,55	0,55
PCS		
DIMENSIONI / DIMENSIONS		
a	230	230
b	65,5	65,5
cut size	200	200

ERCOLE IP54



Incasso LED integrato
Corpo in alluminio pressofuso
Diffusore in PC opale
Riflettore cromato
Driver incluso

Recessed fitting with built-in LED
Die-cast aluminium body
Opal PC diffuser
Driver included

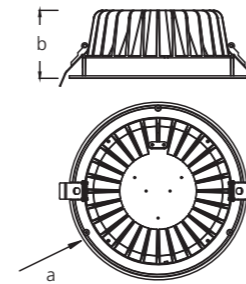

CODICE / CODE	41255	41256
BEAM	90°	90°
COLORE / COLOUR	bianco/white	bianco/white
COLORE LUCE / COLOR T	3000K	4000K
LUMEN	1995	2110
CRI	80	80
LED	EPISTAR	EPISTAR
WATT	23W	23W
SUPPLY	220-240V	220-240V
DRIVER	50.4-59.4V/350mA	50.4-59.4V/350mA
KG	1,22	1,22
PCS		
DIMENSIONI / DIMENSIONS		
a	230	230
b	88	88
cut size	200	200

VULCANO_EVO



Incasso LED integrato
Corpo in TRP
Diffusore in PC opale
Riflettore cromato
Driver integrato

Recessed fitting with built-in LED
TRP body
Opal PC diffuser
Chromed reflector
Built-in driver



CODICE / CODE	40571	40572	40573	40574	40575	40576	40577	40578
BEAM	80°	75°	65°	65°	80°	75°	65°	65°
COLORE / COLOUR	bianco white	bianco white	bianco white	bianco white	bianco white	bianco white	bianco white	bianco white
COLORE LUCE / COLOR T	3000K	3000K	3000K	3000K	4000K	4000K	4000K	4000K
LUMEN	1000	1400	1600	1900	1100	1500	1700	2000
CRI	>80	>80	>80	>80	>80	>80	>80	>80
LED	Everlight	Everlight	Everlight	Everlight	Everlight	Everlight	Everlight	Everlight
WATT	15W	20W	25W	30W	15W	20W	25W	30W
PF	>0,5	>0,5	>0,9	>0,9	>0,5	>0,5	>0,9	>0,9
SUPPLY	220-240V 50/60Hz	220-240V 50/60Hz	220-240V 50/60Hz	220-240V 50/60Hz	220-240V 50/60Hz	220-240V 50/60Hz	220-240V 50/60Hz	220-240V 50/60Hz
KG	0,25	0,35	0,47	0,47	0,25	0,35	0,47	0,47
DRIVER	140mA/90V	160mA/108V	160mA/135V	240mA/108V	140mA/90V	160mA/108V	160mA/135V	240mA/108V
FORO / HOLE	Ø125	Ø160	Ø200	Ø200	Ø125	Ø160	Ø200	Ø200
PCS	40	20	20	20	40	20	20	20
DIMENSIONI / DIMENSIONS								
a	150	190	230	230	150	190	230	230
b	81	91	101,5	101,5	81	91	101,5	101,5



LEDSPOT_TRP1



Incasso LED integrato
Corpo in TRP
Diffusore in PC opale
Driver integrato

Recessed fitting with built-in LED
TRP body
Opal PC diffuser
Built-in driver



CODICE / CODE	40511	40512	40513	40514	40515	40516	40517	40518
COLORE / COLOUR	bianco white	bianco white	bianco white	bianco white	bianco white	bianco white	bianco white	bianco white
COLORE LUCE / COLOR T	3000K	4000K	3000K	4000K	3000K	4000K	3000K	4000K
LUMEN	825	888	1242	1320	2135	2332	2431	2487
CRI	>80	>80	>80	>80	>80	>80	>80	>80
LED	Epistar	Epistar	Epistar	Epistar	Epistar	Epistar	Epistar	Epistar
WATT	10W	10W	15W	15W	25W	25W	30W	30W
PF	>0,5	>0,5	>0,5	>0,5	>0,5	>0,5	>0,9	>0,9
SUPPLY	230V 50/60Hz	230V 50/60Hz	230V 50/60Hz	230V 50/60Hz	230V 50/60Hz	230V 50/60Hz	230V 50/60Hz	230V 50/60Hz
FORO / HOLE	Ø90	Ø90	Ø120	Ø120	Ø170	Ø170	Ø200	Ø200
KG	0,14	0,14	0,20	0,20	0,33	0,33	0,45	0,45
PCS	20	20	20	20	20	20	20	20
DIMENSIONI / DIMENSIONS								
a	120	120	150	150	200	200	230	230
b	60	60	60	60	60	60	60	60



QUADRO_30



Incasso LED integrato
Corpo in TRP
Diffusore PC opale
Driver integrato

Recessed fitting with built-in LED
TRP body
Opal PC diffuser
Built-in driver



CODICE / CODE	40752	40753
BEAM	111°	111°
COLORE / COLOUR	bianco white	bianco white
COLORE LUCE / COLOR T	3000K	4000K
LUMEN	2400	2500
CRI	>80	>80
LED	Everlight	Everlight
WATT	30W	30W
PF	>0.9	>0.9
SUPPLY	220-240V 50/60Hz	220-240V 50/60Hz
KG	0.78	0.78
FORO / HOLE	288x288	288x288
PCS	20	20
DIMENSIONI / DIMENSIONS		
a	300x300	300x300
b	65	65



DIN



Incasso LED integrato
Corpo in pressofusione di alluminio verniciato
Schermo in PC trasparente
Driver incluso

Recessed fitting with built-in LED
Painted die-cast aluminium body
Transparent PC screen
Driver included



CODICE / CODE	40210
BEAM	38°
COLORE / COLOUR	bianco/white
COLORE LUCE / COLOR T	3000K
LUMEN	550
CRI	>80
LED	Refong COB
WATT	9W
PF	>0,5
SUPPLY	230V 50/60Hz
DRIVER	108mA/15-30V
FORO / HOLE	Ø75
KG	0,14
PCS	10
DIMENSIONI / DIMENSIONS	
a	85
b	42

DON



Incasso LED integrato
Corpo in pressofusione di alluminio verniciato
Schermo in PC trasparente
Driver incluso

Recessed fitting with built-in LED
Painted die-cast aluminium body
Transparent PC screen
Driver included



CODICE / CODE	40211
BEAM	25°
COLORE / COLOUR	bianco/white
COLORE LUCE / COLOR T	3000K
LUMEN	550
CRI	>80
LED	Refong COB
WATT	9W
PF	>0,5
SUPPLY	230V 50/60Hz
DRIVER	108mA/15-30V
FORO / HOLE	Ø75
KG	0,14
PCS	10
DIMENSIONI / DIMENSIONS	
a	85
b	65



SPLASH



Incasso GU5,3
Corpo in pressofusione di alluminio verniciato
Schermo in vetro trasparente

Recessed fitting GU5,3
Painted die-cast aluminium body
Transparent glass screen



CODICE / CODE	40326	40327
COLORE / COLOUR	bianco / white	cromo / chrome
LAMP	GU5,3	GU5,3
WATT	Max 35W	Max 35W
SUPPLY	12V	12V
FORO / HOLE	Ø72	Ø72
KG	0,14	0,14
PCS	50	50
DIMENSIONI / DIMENSIONS		
a	82	82
b	36	36

HELIOS_50



Incasso
Corpo in pressofusione di alluminio

Recessed fitting
Painted die-cast aluminium body



CODICE / CODE	41243	41244	41246	41245	41247
COLORE / COLOUR	bianco white	nero black	oro gold	cromo chrome	nikel matt nikel matt
LAMP	GU10	GU10	GU10	GU10	GU10
WATT	Max 50W	Max 50W	Max 50W	Max 50W	Max 50W
SUPPLY	230V	230V	230V	230V	230V
FORO / HOLE	Ø60	Ø60	Ø60	Ø60	Ø60
KG	0,1	0,1	0,1	0,1	0,1
PCS	100	100	100	100	100
DIMENSIONI / DIMENSIONS					
a	80	80	80	80	80
b	23	23	23	23	23

HELIOS_50



Incasso orientabile
Corpo in pressofusione di alluminio

Adjustable recessed fitting
Painted die-cast aluminium body



CODICE / CODE	41248	41249	41251	41250	41252
COLORE / COLOUR	bianco white	nero black	oro gold	cromo chrome	nikel matt nikel matt
LAMP	GU10	GU10	GU10	GU10	GU10
WATT	Max 50W	Max 50W	Max 50W	Max 50W	Max 50W
SUPPLY	230V	230V	230V	230V	230V
FORO / HOLE	Ø70	Ø70	Ø70	Ø70	Ø70
KG	0,1	0,1	0,1	0,1	0,1
PCS	100	100	100	100	100
DIMENSIONI / DIMENSIONS					
a	80	80	80	80	80
b	23	23	23	23	23

SOFFITTO / PARETE

INTERNO



PLAFOLED T



Apparecchio da soffitto LED integrato
Corpo in metallo verniciato
Diffusore in MS
Driver incluso

Ceiling fitting Painted metal body
MS diffuser
Driver included

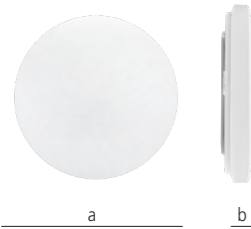

CODICE/CODE	41006	41007	41008	41009	41010	41011
BEAM	130°	130°	130°	130°	130°	130°
COLORE/COLOUR	bianco/white	bianco/white	bianco/white	bianco/white	bianco/white	bianco/white
COLORE/COLOUR T	3000K	4000K	3000K	4000K	3000K	4000K
LUMEN	1820	1900	2430	2500	3180	3190
CRI	>80	>80	>80	>80	>80	>80
LED	NationStar	NationStar	NationStar	NationStar	NationStar	NationStar
WATT	24W	24W	32W	32W	42W	42W
PF	0,5	0,5	0,9	0,9	0,9	0,9
SUPPLY	220-240V, 50/60Hz	220-240V, 50/60Hz	220-240V, 50/60Hz	220-240V, 50/60Hz	220-240V, 50/60Hz	220-240V, 50/60Hz
DRIVER	210mA/115-200V	210mA/115-200V	80mA/432-500V	80mA/432-500V	370mA/115-160V	370mA/115-160V
KG	0.6KG	0.6KG	0.7KG	0.7KG	1KG	1KG
PCS	10	10	10	10	10	10
DIMENSIONI/DIMENSIONS						
a	Ø340	Ø340	Ø390	Ø390	Ø480	Ø480
b	65	65	65	65	78	78

PLAFOLED Q

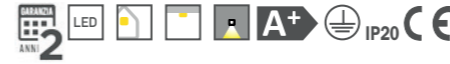

Apparecchio da soffitto LED integrato
Corpo in metallo verniciato
Diffusore in MS
Driver incluso

Ceiling fitting Painted metal body
MS diffuser
Driver included

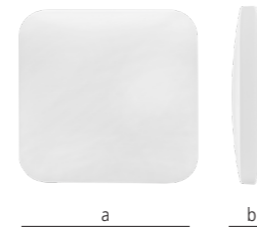

CODICE/CODE	41012	41013	41014	41015
BEAM	120°	120°	120°	120°
COLORE/COLOUR	bianco/white	bianco/white	bianco/white	bianco/white
COLORE/COLOUR T	3000K	4000K	3000K	4000K
LUMEN	2560	2660	3180	3300
CRI	>80	>80	>80	>80
LED	NationStar	NationStar	NationStar	NationStar
WATT	32W	32W	42W	42W
PF	0,5	0,5	0,9	0,9
SUPPLY	220-240V, 50/60Hz	220-240V, 50/60Hz	220-240V, 50/60Hz	220-240V, 50/60Hz
DRIVER	80mA/432-500V	80mA/432-500V	370mA/115-160V	370mA/115-160V
KG	0.7KG	0.7KG	1KG	1KG
PCS	10	10	5	5
DIMENSIONI/DIMENSIONS				
a	330	330	430	430
b	65	65	65	65

HYDRA T



Apparecchio a soffitto
Anello in alluminio
Schermo in PC opale

Ceiling fitting
Aluminium ring
Opal PC screen

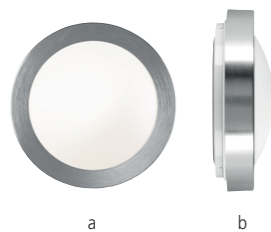

HYDRA Q



Apparecchio a soffitto
Anello in alluminio
Schermo in PC opale

Ceiling fitting
Aluminium ring
Opal PC screen

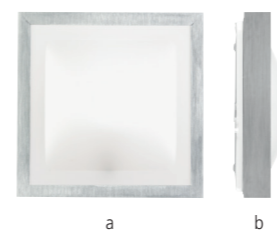

CODICE / CODE	43439	40439	43440	40440
COLORE / COLOUR	bianco/white	alluminio/aluminium	bianco/white	alluminio/aluminium
LAMP	E27	E27	E27	E27
WATT	Max 20W	Max 20W	Max 2x20W	Max 2x20W
SUPPLY	230V 50/60Hz	230V 50/60Hz	230V 50/60Hz	230V 50/60Hz
KG	0,48	0,48	0,48	0,48
PCS	10	10	10	10
DIMENSIONI / DIMENSIONS				
a	270	270	350	350
b	97	97	97	97

CODICE / CODE	43441	40441	43442	40442
COLORE / COLOUR	bianco/white	alluminio/aluminium	bianco/white	alluminio/aluminium
LAMP	E27	E27	E27	E27
WATT	Max 20W	Max 20W	Max 3x20W	Max 3x20W
SUPPLY	230V 50/60Hz	230V 50/60Hz	230V 50/60Hz	230V 50/60Hz
KG	0,85	0,85	1,3	1,3
PCS	10	10	5	5
DIMENSIONI / DIMENSIONS				
a	270	270	370	370
b	85	85	85	85

PANNELLO TONDO



Apparecchio da soffitto LED integrato
Corpo in alluminio verniciato
Diffusore in PMMA
Driver incluso

Ceiling fitting
Painted aluminium body
PMMA diffuser
Driver included

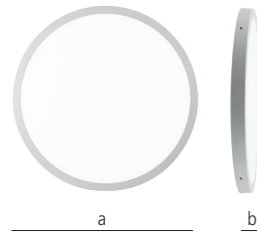

CODICE / CODE	41585	41586
BEAM	120°	120°
COLORE / COLOUR	bianco/white	bianco/white
COLORE LUCE / COLOR T	3000K	4000K
LUMEN	4480	4889
CRI	>80	>80
LED	Epistar	Epistar
WATT	48W	48W
PF	0.9	0.9
SUPPLY	230V 50/60Hz	230V 50/60Hz
DRIVER	1200mA/30-42V	1200mA/30-42V
KG	3,4	3,4
PCS	2	2
DIMENSIONI / DIMENSIONS		
a	Ø600	Ø600
b	40	40

ISIDE



Apparecchio soffitto
Corpo in acciaio
Diffusore in PMMA

Ceiling fitting
Steel body
PMMA diffuser



CODICE / CODE	40378
COLORE / COLOUR	bianco/white
COLORE LUCE / COLOR T	3000K
LUMEN	4000
CRI	>80
LED	Sanan
WATT	50W
PF	0.9
SUPPLY	230V 50/60Hz
KG	2
PCS	2
DIMENSIONI / DIMENSIONS	
a	510
b	100

MAYA



Apparecchio a soffitto
Corpo in materiale plastico
Schermo in PC opale

Ceiling fitting
Plastic body
Opal PC screen



CODICE / CODE	40366	40365
COLORE / COLOUR	bianco white	argento silver
LAMP	E27	E27
WATT	Max 15W	Max 15W
SUPPLY	230V 50/60Hz	230V 50/60Hz
KG	0,4	0,4
PCS	10	10
DIMENSIONI / DIMENSIONS		
a	Ø270	Ø270
b	100	100

DISCO



Apparecchio a soffitto
Corpo in metallo
Schermo in vetro satinato

Ceiling fitting
Metal body
Frosted glass screen

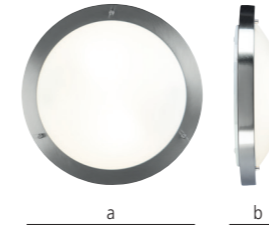

CODICE / CODE	43544	41544	43545	41545
COLORE / COLOUR	bianco white	nikel matt	bianco white	nikel matt
LAMP	E27	E27	E27	E27
WATT	Max 2x28W	Max 2x28W	Max 2x52W	Max 2x52W
SUPPLY	230V 50/60Hz	230V 50/60Hz	230V 50/60Hz	230V 50/60Hz
KG	1,5	1,5	2,8	2,8
PCS	10	10	5	5
DIMENSIONI / DIMENSIONS				
a	Ø300	Ø300	Ø400	Ø400
b	90	90	110	110

LUCE QUADRO



Apparecchio a parete
LED integrato
Corpo in metallo cromato
Diffusore in PC opale

Built-in LED
wall fitting
Chromed metal body
Opal PC diffuser



CODICE / CODE	42612	42613	42614
COLORE / COLOUR	cromo/chrome	cromo/chrome	cromo/chrome
COLORE LUCE / COLOR T	3000K	3000K	3000K
LUMEN	500	750	1000
CRI	>80	>80	>80
LED	Sanan	Sanan	Sanan
WATT	8W	12W	16W
PF	>0,5	>0,5	>0,5
SUPPLY	220mA 18-36V	350mA 24-45V	350mA 24-45V
KG			
PCS	12	12	12
DIMENSIONI / DIMENSIONS			
a	300	450	600
b	40	45	45
c	220	225	225

LUCE QUADRO



Apparecchio a parete
LED integrato
Corpo in metallo cromato
Diffusore in PC opale

Built-in LED
wall fitting
Chromed metal body
Opal PC diffuser



CODICE / CODE	42609	42610	42611
COLORE / COLOUR	cromo/chrome	cromo/chrome	cromo/chrome
COLORE LUCE / COLOR T	3000K	3000K	3000K
LUMEN	500	750	1000
CRI	>80	>80	>80
LED	Sanan	Sanan	Sanan
WATT	8W	12W	16W
PF	>0,5	>0,5	>0,5
SUPPLY	220mA 18-36V	350mA 24-45V	350mA 24-45V
KG			
PCS	12	12	12
DIMENSIONI / DIMENSIONS			
a	300	450	600
b	40	45	45
c	220	225	225

INDUSTRIALE
INTERNO



HORUS



Apparecchio LED integrato
per installazione a sospensione
ed a parete con staffa (accessorio)
Corpo in alluminio
Led CREE/Driver Meanwell

LED fitting to be suspended or wall
mounted through relative bracket
Aluminium body
CREE Led/Meanwell Driver

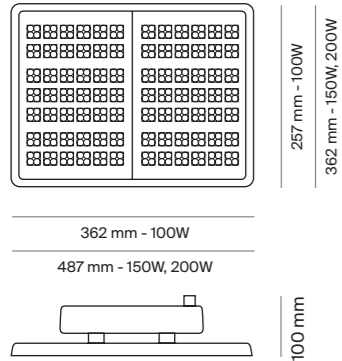

CODICE / CODE	41597	41598	41599
WATT	100W	150W	200W
LUMEN	13000	19500	26000
ANGOLO	80°	80°	80°
COLORE LUCE	4000K	4000K	4000K
CRI	>80	>80	>80
FINITURA	nero	nero	nero
ALIMENTAZIONE	220-240V 50/60Hz	220-240V 50/60Hz	220-240V 50/60Hz
PF	>0,9	>0,9	>0,9
T° D'ESERCIZIO	-40°÷70°C	-40°÷70°C	-40°÷70°C
KG	4,9	6,5	6,5
VITA UTILE MEDIA	50000h	50000h	50000h

ACCESSORI
ACCESSORIES

11555 Staffa/Bracket

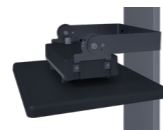

ATON



Apparecchio LED integrato
per installazione a sospensione
o su blindosbarra
Corpo in alluminio estruso
Led CREE/Driver Meanwell

LED fitting to be suspended
or mounted on busways
Extruded aluminium body
CREE Led/Meanwell Driver

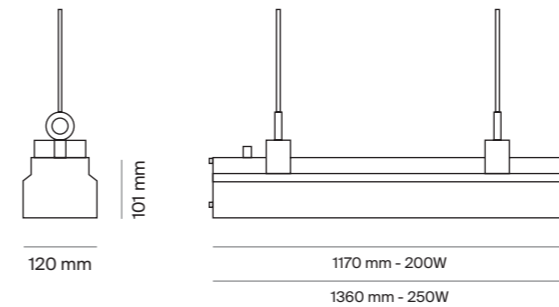

CODICE / CODE	41642	41643
WATT	200W	250W
LUMEN	24000	30000
ANGOLO	60° x 110°	60° x 110°
COLORE LUCE	4000K	4000K
CRI	>80	>80
FINITURA	nero	nero
ALIMENTAZIONE	220-240V 50/60Hz	220-240V 50/60Hz
PF	>0,9	>0,9
T° D'ESERCIZIO	-40°÷70°C	-40°÷70°C
KG	9,2	10,3
VITA UTILE MEDIA	50000h	50000h

PRO_STAGNALED_IP65



Corpo e diffusore in PC
Driver Osram incluso
LED LG
1200mm 12 clips di chiusura
1500mm 14 clips di chiusura

PC body and diffuser
Osram Driver
LG LED
1200mm 12 latches
1500mm 14 latches

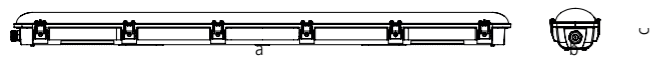

CODICE / CODE	41640	41641
BEAM	120°	120°
COLORE LUCE / COLOR T	4000K	4000K
LUMEN	3900	5900
CRI	>80	>80
LED	LG 2835	LG 2835
WATT	36W	54W
PF	>0,9	>0,9
SUPPLY	AC175-250V	AC175-250V
DRIVER	350mA 55-120V	350mA 55-120V
KG	1,7	2,1
PCS	6	6
DIMENSIONI / DIMENSIONS		
a	1220	1560
b	97	97
c	82	82

Versione con emergenza 4W 3/h
Emergency version 4W 3/h

	41644	41645
BEAM	120°	120°
COLORE LUCE / COLOR T	4000K	4000K
LUMEN	3900	5900
CRI	>80	>80
LED	LG 2835	LG 2835
WATT	36W	54W
PF	>0,9	>0,9
SUPPLY	AC175-250V	AC175-250V
DRIVER	350mA 55-120V	350mA 55-120V
KG	1,7	2,1
PCS	6	6
DIMENSIONI / DIMENSIONS		
a	1220	1560
b	97	97
c	82	82

STAGNA_IP65



Corpo in ABS e diffusore in PS
Base struttura interna in metallo
600mm 4 clips di chiusura
1200mm 10 clips di chiusura
1500mm 12 clips di chiusura
Collegamento diretto tensione di rete
Solo per tubi LED 230V

ABS body + PS diffuser
Internal tray in plated iron
600mm 4 latches
1200mm 10 latches
1500mm 12 latches
Direct connection to mains voltage
Only for LED tubes 230V

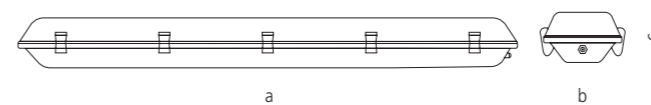

CODICE / CODE	41555	41556	41557	41558	41559	41560
KG	Mono 0,53	Mono 0,90	Mono 1,19	Bi 0,67	Bi 1,22	Bi 1,57
PCS	12	12	8	8	4	4
DIMENSIONI / DIMENSIONS						
a	655	1263	1564	655	1263	1564
b	66	66	66	106	106	106
c	90	90	90	90	90	90

CARONTE



Proiettore con LED LG alta efficienza e driver Meanwell
 Tecnologia avanzata per la gestione dissipazione calore
 Riflettore ad alta efficienza
 Schermo in vetro temperato
 Staffa orientabile
 Soluzione risparmio energetico
 Sostituzione apparecchi ioduri metallici

Projector with built-in high efficiency LG LED and Meanwell Driver
 Advanced heat management technology
 High efficiency reflector
 Tempered glass screen
 Solid adjustability of the bracket
 Perfect energy saving solution replace HID fittings
 Driver included

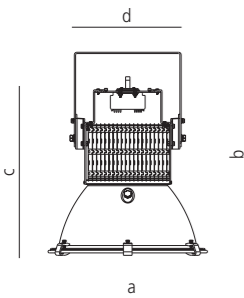

CODICE / CODE	41563	41564	41565	41566	41567	41568	41569	41570
BEAM	60°	60°	90°	90°	60°	60°	90°	90°
COLORE / COLOUR	nero/black	nero/black	nero/black	nero/black	nero/black	nero/black	nero/black	nero/black
COLORE LUCE / COLOR T	4000K	6000K	4000K	6000K	4000K	6000K	4000K	6000K
LUMEN	11000	11640	11000	11640	14000	15050	14000	15050
CRI	>80	>80	>80	>80	>80	>80	>80	>80
LED	LG3030	LG3030	LG3030	LG3030	LG3030	LG3030	LG3030	LG3030
WATT	120W	120W	120W	120W	150W	150W	150W	150W
PF	0,9	0,9	0,9	0,9	0,9	0,9	0,9	0,9
SUPPLY	230V 50/60Hz	230V 50/60Hz	230V 50/60Hz	230V 50/60Hz	230V 50/60Hz	230V 50/60Hz	230V 50/60Hz	230V 50/60Hz
KG	5,3	5,3	5,3	5,3	6,07	6,07	6,07	6,07
PCS	1	1	1	1	1	1	1	1
DIMENSIONI / DIMENSIONS								
a	374	374	374	374	374	374	374	374
b	459	459	459	459	467	467	467	467
c	410	410	410	410	410	410	410	410
d	246	246	246	246	266	266	266	266



PROIETTORI ESTERNI



ATLANTE



Proiettore LED integrato
Corpo in pressofusione di alluminio
Schermo in vetro temperato trasparente
Driver incluso

LED Floodlight
Die-cast aluminium body
Tempered transparent glass
Built-in driver

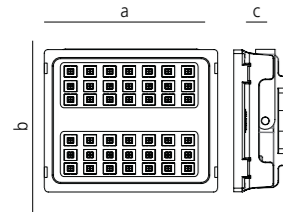

CODICE / CODE	41183	41170	41171	41172
BEAM	85°x95°	85°x95°	85°x95°	85°x95°
COLORE / COLOUR	nero/black	nero/black	nero/black	nero/black
COLORE LUCE / COLOR T	4000K	4000K	4000K	4000K
LUMEN	4700	9500	14250	19000
CRI	>80	>80	>80	>80
LED	BRIDGELUX SMD 2835	BRIDGELUX SMD 2835	BRIDGELUX SMD 2835	BRIDGELUX SMD 2835
WATT	50W	100W	150W	200W
PF	>0,9	>0,9	>0,9	>0,9
SUPPLY	220-240V 50/60Hz	220-240V 50/60Hz	220-240V 50/60Hz	220-240V 50/60Hz
KG	1	2,4	4,5	5,7
PCS	6	6	4	4
DIMENSIONI / DIMENSIONS				
a	191	262	340	390
b	141	210	275	300
c	67	70	50	50



LAMPO



Proiettore LED integrato nero
Corpo in pressofusione di alluminio
Diffusore in vetro trasparente e driver integrato

Black LED Floodlight
Die-cast aluminium body
Transparent glass diffuser
Built-in driver

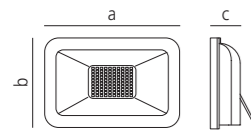

ACCESSORI
ACCESSORIES

11074 Picchetto nero/Black spike

CODICE / CODE	40552	40553	40554	40555	40568
BEAM	120°	120°	120°	120°	120°
COLORE / COLOUR	nero/black	nero/black	nero/black	nero/black	nero/black
COLORE LUCE / COLOR T	3000K	3000K	3000K	3000K	3000K
LUMEN	802	1605	2410	4050	7203
CRI	>80	>80	>80	>80	>80
WATT	10W	20W	30W	50W	100W
PF	> 0,9	> 0,9	> 0,9	> 0,9	> 0,9
SUPPLY	220/240V 50/60Hz	220/240V 50/60Hz	220/240V 50/60Hz	220/240V 50/60Hz	220/240V 50/60Hz
KG	0,214	0,374	0,564	0,755	1,4
PCS	40	40	20	20	10
DIMENSIONI / DIMENSIONS					
a	100	147	190	220	300
b	80	103	132	155	200
c	20	18	18	19	20

CODICE / CODE	40556	40557	40558	40559	40569
BEAM	120°	120°	120°	120°	120°
COLORE / COLOUR	nero/black	nero/black	nero/black	nero/black	nero/black
COLORE LUCE / COLOR T	4000K	4000K	4000K	4000K	4000K
LUMEN	830	1700	2500	4130	7380
CRI	>80	>80	>80	>80	>80
WATT	10W	20W	30W	50W	100W
PF	> 0,9	> 0,9	> 0,9	> 0,9	> 0,9
SUPPLY	220/240V 50/60Hz	220/240V 50/60Hz	220/240V 50/60Hz	220/240V 50/60Hz	220/240V 50/60Hz
KG	0,214	0,374	0,564	0,755	1,4
PCS	40	40	20	20	10
DIMENSIONI / DIMENSIONS					
a	100	147	190	220	300
b	80	103	132	155	200
c	20	18	18	19	20

CODICE / CODE	40560	40561	40562	40563	40570
BEAM	120°	120°	120°	120°	120°
COLORE / COLOUR	nero/black	nero/black	nero/black	nero/black	nero/black
COLORE LUCE / COLOR T	6000K	6000K	6000K	6000K	6000K
LUMEN	850	1720	2700	4500	7470
CRI	>80	>80	>80	>80	>80
WATT	10W	20W	30W	50W	100W
PF	> 0,9	> 0,9	> 0,9	> 0,9	> 0,9
SUPPLY	220/240V 50/60Hz	220/240V 50/60Hz	220/240V 50/60Hz	220/240V 50/60Hz	220/240V 50/60Hz
KG	0,214	0,374	0,564	0,755	1,4
PCS	40	40	20	20	10
DIMENSIONI / DIMENSIONS					
a	100	147	190	220	300
b	80	103	132	155	200
c	20	18	18	19	20

LAMPO



Proiettore LED integrato bianco
Corpo in pressofusione di alluminio
Diffusore in vetro trasparente e driver integrato

White LED Floodlight
Die-cast aluminium body
Transparent glass diffuser
Built-in driver

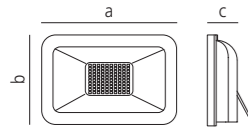

ACCESSORI
ACCESSORIES

11075 Picchetto bianco/White spike

CODICE / CODE	41149	41150	41151	41152	41161
BEAM	120°	120°	120°	120°	120°
COLORE / COLOUR	bianco/white	bianco/white	bianco/white	bianco/white	bianco/white
COLORE LUCE / COLOR T	3000K	3000K	3000K	3000K	3000K
LUMEN	802	1605	2410	4050	7203
CRI	>80	>80	>80	>80	>80
WATT	10W	20W	30W	50W	100W
PF	> 0,9	> 0,9	> 0,9	> 0,9	> 0,9
SUPPLY	220/240V 50/60Hz	220/240V 50/60Hz	220/240V 50/60Hz	220/240V 50/60Hz	220/240V 50/60Hz
KG	0,214	0,374	0,564	0,755	1,4
PCS	40	40	20	20	10
DIMENSIONI / DIMENSIONS					
a	100	147	190	220	300
b	80	103	132	155	200
c	20	18	18	19	20

CODICE / CODE	41153	41154	41155	41156	41162
BEAM	120°	120°	120°	120°	120°
COLORE / COLOUR	bianco/white	bianco/white	bianco/white	bianco/white	bianco/white
COLORE LUCE / COLOR T	4000K	4000K	4000K	4000K	4000K
LUMEN	830	1700	2500	4130	7380
CRI	>80	>80	>80	>80	>80
WATT	10W	20W	30W	50W	100W
PF	> 0,9	> 0,9	> 0,9	> 0,9	> 0,9
SUPPLY	220/240V 50/60Hz	220/240V 50/60Hz	220/240V 50/60Hz	220/240V 50/60Hz	220/240V 50/60Hz
KG	0,214	0,374	0,564	0,755	1,4
PCS	40	40	20	20	10
DIMENSIONI / DIMENSIONS					
a	100	147	190	220	300
b	80	103	132	155	200
c	20	18	18	19	20

CODICE / CODE	41157	41158	41159	41160	41163
BEAM	120°	120°	120°	120°	120°
COLORE / COLOUR	bianco/white	bianco/white	bianco/white	bianco/white	bianco/white
COLORE LUCE / COLOR T	6000K	6000K	6000K	6000K	6000K
LUMEN	850	1720	2700	4500	7470
CRI	>80	>80	>80	>80	>80
WATT	10W	20W	30W	50W	100W
PF	> 0,9	> 0,9	> 0,9	> 0,9	> 0,9
SUPPLY	220/240V 50/60Hz	220/240V 50/60Hz	220/240V 50/60Hz	220/240V 50/60Hz	220/240V 50/60Hz
KG	0,214	0,374	0,564	0,755	1,4
PCS	40	40	20	20	10
DIMENSIONI / DIMENSIONS					
a	100	147	190	220	300
b	80	103	132	155	200
c	20	18	18	19	20

LAMPO C/SENSORE



Proiettore LED integrato nero con sensore orientabile
Corpo in pressofusione di alluminio
Diffusore in vetro trasparente e driver integrato

Black LED Floodlight with adjustable sensor
Die-cast aluminium body
Transparent glass diffuser
Built-in driver

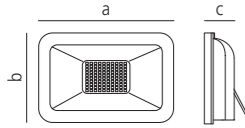

ACCESSORI
ACCESSORIES

11074 Picchetto nero/Black spike
11075 Picchetto bianco/White spike

CODICE / CODE	41224	41225	41226	41227
BEAM	120°	120°	120°	120°
COLORE / COLOUR	nero/black	nero/black	nero/black	nero/black
COLORE LUCE / COLOR T	4000K	4000K	4000K	4000K
LUMEN	830	1700	2500	4130
CRI	>80	>80	>80	>80
WATT	10W	20W	30W	50W
PF	> 0,9	> 0,9	> 0,9	> 0,9
SUPPLY	220/240V 50/60Hz	220/240V 50/60Hz	220/240V 50/60Hz	220/240V 50/60Hz
KG	0,248	0,418	0,608	0,799
PCS	40	40	20	20
DIMENSIONI / DIMENSIONS				
a	100	150	192	225
b	80	107	136	160
c	12,5	14,8	15	16,6

CODICE / CODE	41228	41229	41230	41231
BEAM	120°	120°	120°	120°
COLORE / COLOUR	nero/black	nero/black	nero/black	nero/black
COLORE LUCE / COLOR T	6000K	6000K	6000K	6000K
LUMEN	850	1720	2700	4500
CRI	>80	>80	>80	>80
WATT	10W	20W	30W	50W
PF	> 0,9	> 0,9	> 0,9	> 0,9
SUPPLY	220/240V 50/60Hz	220/240V 50/60Hz	220/240V 50/60Hz	220/240V 50/60Hz
KG	0,248	0,418	0,608	0,799
PCS	40	40	20	20
DIMENSIONI / DIMENSIONS				
a	100	150	192	225
b	80	107	136	160
c	12,5	14,8	15	16,6

CODICE / CODE	41232	41233	41234	41235
BEAM	120°	120°	120°	120°
COLORE / COLOUR	bianco/white	bianco/white	bianco/white	bianco/white
COLORE LUCE / COLOR T	4000K	4000K	4000K	4000K
LUMEN	830	1700	2500	4130
CRI	>80	>80	>80	>80
WATT	10W	20W	30W	50W
PF	> 0,9	> 0,9	> 0,9	> 0,9
SUPPLY	220/240V 50/60Hz	220/240V 50/60Hz	220/240V 50/60Hz	220/240V 50/60Hz
KG	0,248	0,418	0,608	0,799
PCS	40	40	20	20
DIMENSIONI / DIMENSIONS				
a	100	150	192	225
b	80	107	136	160
c	12,5	14,8	15	16,6

CODICE / CODE	41236	41237	41238	41239
BEAM	120°	120°	120°	120°
COLORE / COLOUR	bianco/white	bianco/white	bianco/white	bianco/white
COLORE LUCE / COLOR T	6000K	6000K	6000K	6000K
LUMEN	850	1720	2700	4500
CRI	>80	>80	>80	>80
WATT	10W	20W	30W	50W
PF	> 0,9	> 0,9	> 0,9	> 0,9
SUPPLY	220/240V 50/60Hz	220/240V 50/60Hz	220/240V 50/60Hz	220/240V 50/60Hz
KG	0,248	0,418	0,608	0,799
PCS	40	40	20	20
DIMENSIONI / DIMENSIONS				
a	100	150	192	225
b	80	107	136	160
c	12,5	14,8	15	16,6

SOFFITTO / PARETE

ESTERNI



ZAGOR



Apparecchio a soffitto LED integrato
con sensore di presenza
Corpo in termoplastico
Diffusore in PC opale

Built-in LED downlight with integrated
PIR sensor
Thermoplastic body
Opal PC diffuser

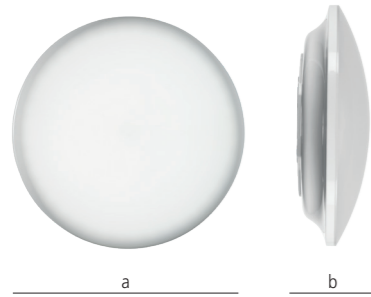

Sensore di presenza 5/6 mt
Microwave sensor 5/6 mt

CODICE / CODE	42577	42578
COLORE / COLOUR	bianco/white	bianco/white
COLORE LUCE / COLOR T	4000K	6000K
LUMEN	3000	3150
CRI	80	80
LED	Sanan	Sanan
WATT	30W	30W
PF	0,9	0,9
SUPPLY	230V 50/60Hz	230V 50/60Hz
KG	0,152	0,152
PCS	20	20
DIMENSIONI / DIMENSIONS		
a	350	350
b	102	102

MOON



Apparecchio a soffitto LED integrato
Corpo in alluminio verniciato
Schermo in PC opale
Driver integrato

Ceiling fitting with built-in LED
Painted aluminium body
Opal PC screen
Built-in driver

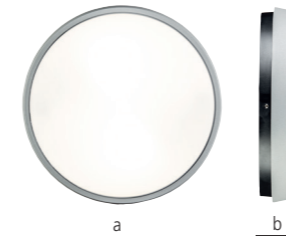

CODICE / CODE	40232	40234
COLORE / COLOUR	bianco/white	bianco/white
COLORE LUCE / COLOR T	3000K	5000K
LUMEN	2000	2100
CRI	>80	>80
LED	SMD Edison	SMD Edison
WATT	26W	26W
PF	0,95	0,95
SUPPLY	230V 50/60Hz	230V 50/60Hz
KG	0,81	0,81
PCS	8	8
DIMENSIONI / DIMENSIONS		
a	240	240
b	45	45

LUNA_T



Apparecchio LED integrato
Corpo in TRP
Schermo in PC opale
Driver integrato

Built-in LED fitting
TRP body
Opal PC screen
Built-in driver

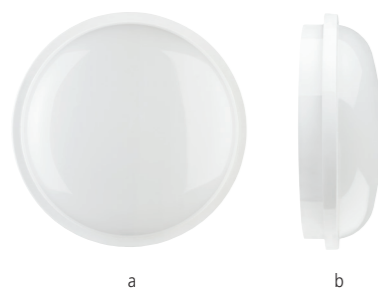

CODICE / CODE	40303	40304
BEAM	110°	110°
COLORE / COLOUR	bianco/white	bianco/white
COLORE LUCE / COLOR T	4000K	4000K
LUMEN	1250	1650
CRI	>80	>80
LED	Epistar	Epistar
WATT	15W	20W
PF	>0,5	>0,5
SUPPLY	230V 50/60Hz	230V 50/60Hz
KG	0,25	0,40
PCS	20	20
DIMENSIONI / DIMENSIONS		
a	167	221
b	62	72

LUNA_Q



Apparecchio LED integrato
Corpo in TRP
Schermo in PC opale
Driver integrato

Built-in LED fitting
TRP body
Opal PC screen
Built-in driver



CODICE / CODE	40305	40306
BEAM	110°	110°
COLORE / COLOUR	bianco/white	bianco/white
COLORE LUCE / COLOR T	4000K	4000K
LUMEN	1250	1650
CRI	>80	>80
LED	Epistar	Epistar
WATT	15W	20W
PF	>0,5	>0,5
SUPPLY	230V 50/60Hz	230V 50/60Hz
KG	0,29	0,42
PCS	20	20
DIMENSIONI / DIMENSIONS		
a	215	271
b	115	146
c	62	76

LADY_T



Apparecchio a soffitto
Corpo in pressofusione di alluminio verniciato
Schermo in PC opale

Recessed fitting with
built-in LED
TRP body
Opal PC diffuser

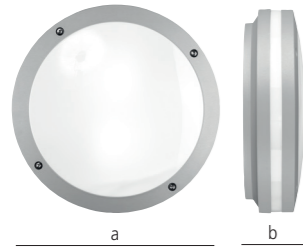

CODICE / CODE	40323
COLORE / COLOUR	grigio/grey
LAMP	E27
WATT	Max 2x20W
SUPPLY	230V 50/60Hz
KG	1,2
PCS	6
DIMENSIONI / DIMENSIONS	
a	300
b	86

LADY_Q



Apparecchio a soffitto
Corpo in pressofusione di alluminio verniciato
Schermo in PC opale

Ceiling fitting
Painted die-cast aluminium body
Opal PC screen

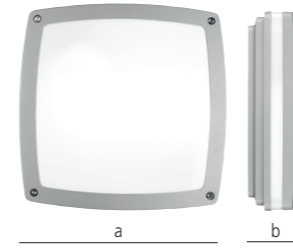

CODICE / CODE	40324
COLORE / COLOUR	grigio/grey
LAMP	E27
WATT	Max 2x20W
SUPPLY	230V 50/60Hz
KG	1,2
PCS	6
DIMENSIONI / DIMENSIONS	
a	300
b	86

SIGNUS



Apparecchio a soffitto
Base in pressofusione di alluminio
Schermo in PC opale

Ceiling fitting
Die-cast aluminium base
Opal PC screen

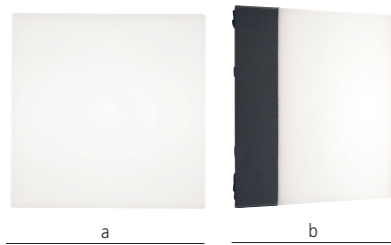

CODICE / CODE	40154	40155
COLORE / COLOUR	nero/black	nero/black
LAMP	Gx53-1	E27
WATT	Max 11W	Max 2x15W
SUPPLY	230V 50/60Hz	230V 50/60Hz
KG	0,7	1,4
PCS	12	6
DIMENSIONI / DIMENSIONS		
a	142	207
b	111	141

PROTEO



Apparecchio a parete
Corpo in pressofusione di alluminio verniciato
Diffusore in PC opale

Wall fitting
Painted die-cast aluminium body
Opal PC diffuser



CODICE / CODE	40348
COLORE / COLOUR	nero/black
LAMP	E27
WATT	Max 42W
SUPPLY	230V 50/60Hz
KG	1
PCS	8
DIMENSIONI / DIMENSIONS	
a	165
b	165
c	171

WALLY



Apparecchio a parete
Corpo in pressofusione di alluminio verniciato
Diffusore in PC opale

Wall fitting
Painted die-cast aluminium body
Opal PC diffuser



CODICE / CODE	42043	42034
COLORE / COLOUR	grigio/grey	nero/black
LAMP	E27	E27
WATT	Max 52W	Max 52W
SUPPLY	230V 50/60Hz	230V 50/60Hz
KG	0,9	0,9
PCS	12	12
DIMENSIONI / DIMENSIONS		
a	250	250
b	120	120
c	135	135

WALLY OPEN



Apparecchio a parete
Corpo in pressofusione di alluminio verniciato
Diffusore in PC opale

Wall fitting
Painted die-cast aluminium body
Opal PC diffuser



CODICE / CODE	40205
COLORE / COLOUR	grigio/grey
LAMP	E27
WATT	Max 52W
SUPPLY	230V 50/60Hz
KG	0,88
PCS	12
DIMENSIONI / DIMENSIONS	
a	250
b	120
c	135

ELEGANT



Paletto
Corpo in pressofusione di alluminio verniciato
Diffusore in PC opale

Pole
Painted die-cast aluminium body
Opal PC diffuser

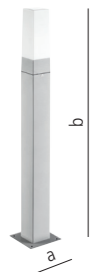

CODICE / CODE	40322
COLORE / COLOUR	grigio/grey
LAMP	E27
WATT	Max 15W
SUPPLY	230V 50/60Hz
KG	1,4
PCS	6
DIMENSIONI / DIMENSIONS	
a	113
b	700

RINGO



Incasso calpestabile LED integrato
Corpo in alluminio anodizzato
Cassaforma in PVC
Driver escluso

Walk-over recessed fitting with built-in LED
Anodized aluminium body
PVC framework
Driver not included

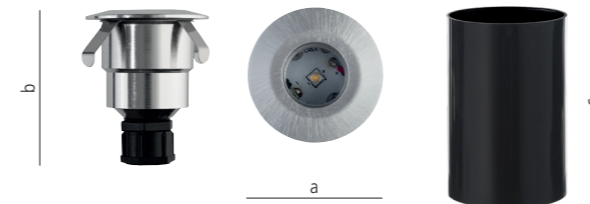

CODICE / CODE	42536	42541
BEAM	60°	60°
COLORE LUCE / COLOR T	3000K	5000K
LUMEN	70	90
LED	RE-FOND	RE-FOND
WATT	1W	1W
SUPPLY	12V DC/AC	12V DC/AC
FORO / HOLE	ø35	ø35
KG	0.15	0.15
PCS	50	50
DIMENSIONI / DIMENSIONS		
a	40	40
b	57	57
c	70	70

KANDO_T



Incasso calpestabile
Corpo in pressofusione di alluminio
Anello in acciaio inox AISI 316
Vetro temperato trasparente
Cassaforma in PVC

Walk-over recessed fitting
Die-cast aluminium body
AISI 316 stainless steel ring
Transparent tempered glass
PVC frame-work



CODICE / CODE	40157
COLORE / COLOUR	INOX
LAMP	GU10
WATT	HALO Max 50W
SUPPLY	230V 50/60Hz
FORO / HOLE	ø100
KG	0,7
PCS	20
DIMENSIONI / DIMENSIONS	
a	105
b	100
c	115
d	140

ACCESSORI 40015 Connettore IP67 una via
ACCESSORIES 40016 Connettore IP67 due via



KANDO_Q



Incasso calpestabile
Corpo in pressofusione di alluminio
Anello in acciaio inox AISI 316
Vetro temperato trasparente
Cassaforma in PVC

Walk-over recessed fitting
Die-cast aluminium body
AISI 316 stainless steel ring
Transparent tempered glass
PVC frame-work



CODICE / CODE	42535
COLORE / COLOUR	INOX
LAMP	GU10
WATT	HALO Max 50W
SUPPLY	230V 50/60Hz
FORO / HOLE	ø100
KG	0,7
PCS	20
DIMENSIONI / DIMENSIONS	
a	105
b	100
c	115
d	140

ACCESSORI 40015 Connettore IP67 una via
ACCESSORIES 40016 Connettore IP67 due via



BRICK



Segnapasso LED integrato
Corpo in ABS
Cornice in acciaio inox
Schermo in PC trasparente
Cassaforma in PVC
Driver integrato

Wall-step with built-in LED
ABS body
Stainless steel frame
Transparent PC screen
PVC frame-work
Built-in driver

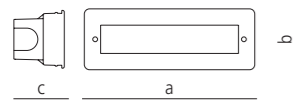
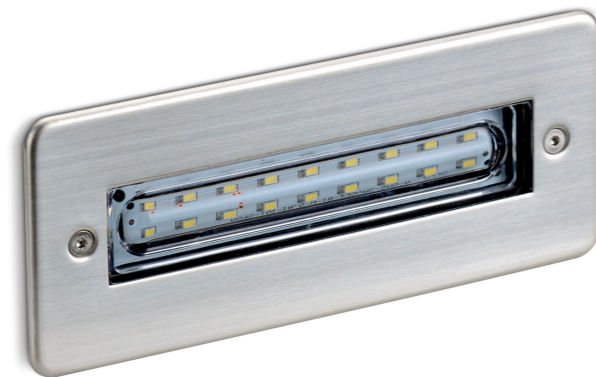

CODICE / CODE	45608	45609	45598	45599
COLORE LUCE / COLOR T	3000K	3000K	5000K	5000K
LUMEN	65	130	90	195
LED	RE-FOND	RE-FOND	RE-FOND	RE-FOND
WATT	1,5W	3,2W	1,5W	3,2W
SUPPLY	230V 50/60Hz	230V 50/60Hz	230V 50/60Hz	230V 50/60Hz
FORO / HOLE	139x56	190x65	139x56	190x65
KG	0,3	0,83	0,3	0,83
PCS	50	12	50	12
DIMENSIONI / DIMENSIONS				
a	146	196	146	196
b	60	70	60	70
c	60	60	60	60

BRICK



Segnapasso LED integrato
Corpo in ABS
Cornice in acciaio inox
Schermo in PC opale
Cassaforma in PVC
Driver integrato

Wall-step with built-in LED
ABS body
Stainless steel frame
Opal PC screen
PVC frame-work
Built-in driver

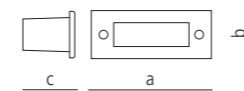

CODICE / CODE	45610	45611	45601	45600
COLORE LUCE / COLOR T	3000K	3000K	5000K	5000K
LUMEN	35	40	46	60
LED	RE-FOND	RE-FOND	RE-FOND	RE-FOND
WATT	0,8W	1W	0,8W	1W
SUPPLY	230V 50/60Hz	230V 50/60Hz	230V 50/60Hz	230V 50/60Hz
FORO / HOLE	67x62	105x32	67x62	105x32
KG	0,17	0,2	0,17	0,2
PCS	50	50	50	50
DIMENSIONI / DIMENSIONS				
a	70	110	70	110
b	70	44	70	44
c	55	54	55	54

TRASFORMATORI ACCESSORI



TRASFORMATORI ELETTRONICI

Trasformatore elettronico LED 12V

LED electronic transformer 12V



CODICE / CODE	21918
	220-240V AC / 50Hz Collegare max 3 lampadine LED Connect max 3 LED bulbs
PRIMARIO / MAINS	
SECONDARIO / SECONDARY	12V
W	2-30W
IP	20
DIMENSIONS	80 x 38 x H28



CODICE / CODE	22918
	220-240V AC / 50Hz Collegare max 4/5 lampadine LED Connect max 4/5 LED bulbs
PRIMARIO / MAINS	
SECONDARIO / SECONDARY	12V
W	2-50W
IP	20
DIMENSIONS	117 x 32 x H20

KIT GU10/GZ10

Kit GU10/GZ 10



CODICE / CODE	40482
----------------------	--------------

PRICE LIST

[Redacted]

[Redacted]

[Redacted]

[Redacted]

[Redacted]

[Redacted]

[Redacted]

[Redacted]

[Redacted]

[Redacted]

[Redacted]

[Redacted]

[Redacted]

[Redacted]

[Redacted]

PRICE LIST

LISTINO IVA ESCLUSA – ECO-FEE INCLUSO

Codice	€	Pag	Codice	€	Pag	Codice	€	Pag	Codice	€	Pag	Codice	€	Pag	Codice	€	Pag
11074	4.00	54	40442	59.43	35	40753	43.30	22	41228	21.50	59	41563	474.00	48	42540	28.80	10,11
11075	4.00	56	40482	2.42	81	41006	33.00	32	41229	29.60	59	41564	474.00	48	42541	44.10	73
11622/2	18.90	8,9	40511	18.90	20	41007	33.00	32	41230	37.90	59	41565	474.00	48	42542	54.00	10,11
11622/3	30.90	10,11	40512	18.90	20	41008	46.80	32	41231	46.90	59	41566	474.00	48	42577	89.00	62
21918	11.00	80	40513	29.88	20	41009	46.80	32	41232	21.50	59	41567	597.00	48	42578	89.00	62
22918	28.00	80	40514	29.88	20	41010	69.00	32	41233	29.60	59	41568	597.00	48	42609	109.00	41
40015	7.25	74, 75	40515	36.30	20	41011	69.00	32	41234	37.90	59	41569	597.00	48	42610	129.00	41
40016	11.87	74, 75	40516	36.30	20	41012	45.60	33	41235	46.90	59	41570	597.00	48	42611	149.00	41
40154	44.63	68	40517	38.94	20	41013	45.60	33	41236	21.50	59	41585	156.00	36	42612	109.00	40
40155	72.98	68	40518	38.94	20	41014	63.00	33	41237	29.60	59	41586	156.00	36	42613	129.00	40
40157	41.48	74	40552	9.90	55	41015	63.00	33	41238	37.90	59	41597	417.00	44	42614	149.00	40
40182	93.45	74	40553	15.00	55	41149	9.90	57	41239	46.90	59	41598	470.00	44	43439	28.49	34
40205	34.65	71	40554	24.60	55	41150	15.00	57	41243	5.20	28	41599	615.00	44	43440	41.40	34
40210	32.44	24	40555	33.60	55	41151	24.60	57	41244	5.20	28	41640	87.60	46	43441	39.07	35
40211	32.44	25	40556	9.90	55	41152	33.60	57	41245	6.20	28	41641	110.40	46	43442	58.10	35
40232	136.50	63	40557	15.00	55	41153	9.90	57	41246	6.20	28	41642	609.00	45	43544	34.37	39
40234	136.50	63	40558	24.60	55	41154	15.00	57	41247	6.20	28	41643	729.00	45	43545	46.88	39
40303	22.14	64	40559	33.60	55	41155	24.60	57	41248	6.40	29	41644	206.60	46	45598	33.60	76
40304	26.10	64	40560	9.90	55	41156	33.60	57	41249	6.40	29	41645	229.40	46	45599	44.63	76
40305	22.14	65	40561	15.00	55	41157	9.90	57	41250	7.80	29	41649	75.00	8	45600	31.40	77
40306	26.10	65	40562	24.60	55	41158	15.00	57	41251	7.80	29	41650	75.00	8	45601	31.40	77
40314	42.00	8,9,10,11,12	40563	33.60	55	41159	24.60	57	41252	7.80	29	41651	82.00	10	45608	33.60	76
40322	78.00	72	40568	60.00	55	41160	33.60	57	41253	55.80	16	41652	82.00	10	45609	44.63	76
40323	61.95	66	40569	60.00	55	41161	60.00	57	41254	55.80	16	41653	85.00	9	45610	31.40	77
40324	61.95	67	40570	60.00	55	41162	60.00	57	41255	84.54	17	41654	85.00	9	45611	31.40	77
40326	11.34	27	40571	21.60	18	41163	60.00	57	41256	84.54	17	41655	92.00	11			
40327	12.43	27	40572	29.80	18	41170	150.00	52	41544	34.59	39	41656	92.00	11			
40348	65.78	69	40573	37.00	18	41171	234.00	52	41545	48.04	39	41657	57.00	12			
40365	15.75	38	40574	40.00	18	41172	288.00	52	41555	17.36	47	42034	44.52	70			
40366	15.75	38	40575	21.60	18	41183	70.00	52	41556	23.56	47	42043	44.52	70			
40378	139.36	37	40576	29.80	18	41224	21.50	59	41557	35.96	47	42535	41.48	75			
40439	28.49	34	40577	37.00	18	41225	29.60	59	41558	21.70	47	42536	44.10	73			
40440	41.89	34	40578	40.00	18	41226	37.90	59	41559	29.76	47	42538	42.00	8,9			
40441	39.07	35	40752	43.30	22	41227	46.90	59	41560	39.65	47	42539	22.80	8,9			

I nostri prodotti sono soggetti a continui sviluppi e cambiamenti. Ci riserviamo il diritto di mutare le specifiche o eliminare alcuni modelli senza preavviso. I colori stampati in questo catalogo non possono produrre fedelmente le tinte dei nostri prodotti. Pertanto sono da considerarsi puramente indicativi. È vietata la riproduzione, anche parziale, di questo catalogo in qualsiasi forma e su qualsiasi supporto senza autorizzazione.

Our products are subjected to continuous changes and developments. We reserve the right to modify the specification or eliminate some models without notice. The colours printed in this catalogue may not reproduce faithfully the hues of the products and have to be considered merely indicative. Total or partial reproduction of this catalogue in any form is not allowed without our prior consent.

INDICE ALFABETICO

ATLANTE	52	PANNELLO LED 30X120	10
ATON	45	PANNELLO LED 30X120 UGR<19	11
BRICK	76	PANNELLO TONDO	36
CARONTE	48	PLAFOLED_Q	33
DIN	24	PLAFOLED_T	32
DON	25	PRO_STAGNALED_IP65	46
DISCO	39	PROTEO	69
ERCOLE	16	QUADRO_30	22
ERCOLE IP54	17	RINGO	73
ELEGANT	72	SIGNUS	68
HELIOS_50 FISSO	28	SPLASH	27
HELIOS_50 REGOLABILE	29	STAGNA_IP65	47
HYDRA_Q	35	TRASFORMATORI ELETTRONICI	80
HYDRA_T	34	VULCANO EVO	18
HORUS	44	WALLY	70
ISIDE	37	WALLY OPEN	71
KANDO_Q	75	ZAGOR	62
KANDO_T	74		
KIT GU10/GZ/10	81		
LADY_Q	67		
LADY_T	66		
LAMPO	54		
LAMPO C/SENSORE	58		
LEDSPOT_TRP1	20		
LUCE QUADRO	40		
LUNA_O	65		
LUNA_T	64		
MAYA	38		
MOON	63		
PANNELLO BACKLITE	12		
PANNELLI LED 60X60	08		
PANNELLO LED 60X60 UGR<19	09		



MARINOCRISTAL

Marino Cristal S.p.A.

Via Guardia del Consiglio 29

47899 Serravalle - Rep. di San Marino

Tel. (+378) 0549-901188

Fax (+378) 0549-900612

www.marinocristal.com

email: marinocristal@marinocristal.com

È vietata la riproduzione anche parziale di questo catalogo
It is forbidden to reproduce any part of this catalogue